

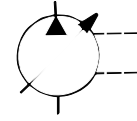

PUMP, VARIABLE DELIVERY PVWJ 025 WITHOUT CONTROLS

ENGINEERING

1



Installation Drawing

Basic Pump Without Control – Side Ported

OPTIONAL SAE "B-B"
SPLINE SHAFT
CODE "C"

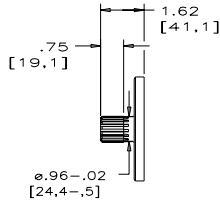

VIEW SHOWING OPTIONAL
SPLINE SHAFT
SAE INVOLUTE SPLINE
15 TEETH 16/32 PITCH
.995 [25.27] MAJOR DIA.

OPTIONAL SAE "B"
SPLINE SHAFT
CODE "S"

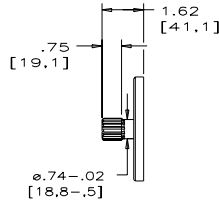

VIEW SHOWING OPTIONAL
SPLINE SHAFT
SAE INVOLUTE SPLINE
13 TEETH 16/32 PITCH
.859 [21.82] MAJOR DIA.

OPTIONAL SAE "B"
SPLINE SHAFT
CODE "D"

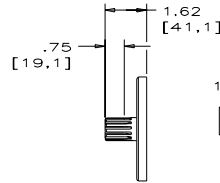

VIEW SHOWING OPTIONAL
SPLINE SHAFT
SAE INVOLUTE SPLINE
13 TEETH 16/32 PITCH
.859 [21.82] MAJOR DIA.
(INDUSTRIAL VERSION)

OPTIONAL SAE "B-B"
KEYED SHAFT
CODE "B"

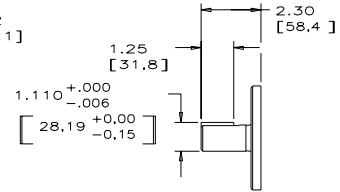

VIEW SHOWING OPTIONAL
KEYED SHAFT
ø1.000-.001 [25.40-.025]
W/ .250 [6.35] SQ. KEY

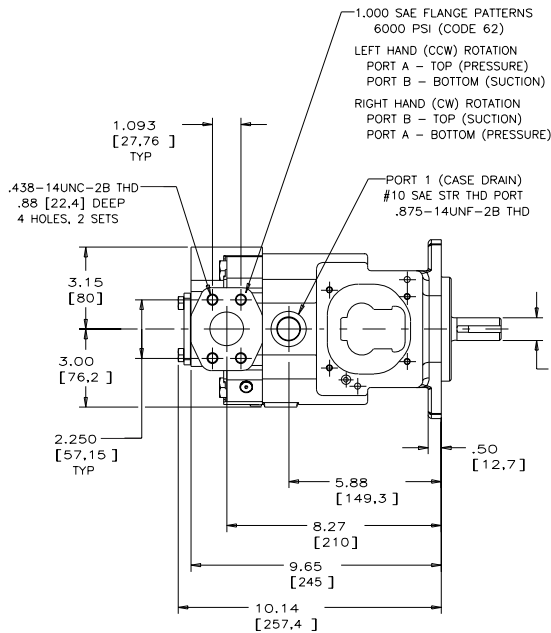

NOTES:

- 1) PUMPS ARE DESIGNED FOR ONE-WAY SERVICE.
- 2) THESE UNITS ARE DESIGNED TO RUN CASE FULL OF FLUID AT ALL TIMES. FILL CASE BEFORE STARTING AND CONNECT DRAIN LINES ACCORDINGLY.
- 3) NUMERICAL DIMENSIONS GIVEN IN INCHES/[MM].
- 4) NET WEIGHT- 58 LBS. [26.31 KG].

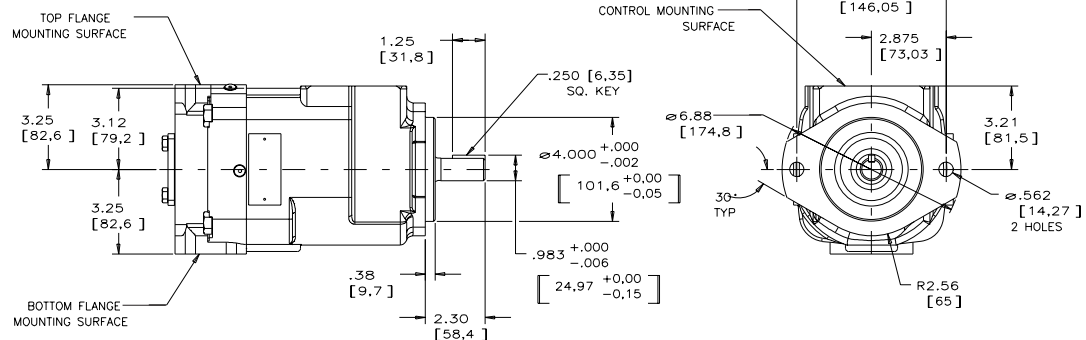

520034-202

Telephone: (414) 327-1700
Fax: (414) 327-0532

OILGEAR
2300 So. 51st. Street
Milwaukee, WI USA 53219

Issued: Oct., 2006
DS-47484